

Series 6000 brass super-rapid fittings for plastic tubes

Tube external diameters: 3, 4, 5, 6, 8, 10, 12, 14, 16 mm

Fittings threads: metric (M3, M5, M6, M7), BSP (G1/8, G1/4, G3/8, G1/2, G3/4), BSPT (R1/8, R1/4, R3/8, R1/2)

SERIES 6000 BRASS SUPER-RAPID FITTINGS



Series 6000 super-rapid fittings have been designed with a special collet which provides an homogeneous tight on the whole surface of plastic tubes, thus ensuring high reliability and a long service life, also after connections and disconnections of the tube are repeated several times. Many types of threads are also available: metric, BSP and BSPT.

The Sprint® models are characterized by great adaptability of male threads with BSP parallel (ISO-228) female threads even in the presence of non-flat or irregular surfaces. This is possible thanks to a Teflon ring on the male thread, which guarantees a perfect seal between the two threads.

The wide range of these fittings includes the LF version ("Stop Fitting") which is equipped with a self-retaining device interrupting the air flow when the tube is disconnected and restores it when reconnected.

GENERAL DATA

Diameters	ø 4 - 5 - 6 - 8 - 10 - 12 - 14 - 16 mm Micro models: ø 3 - 4 - 6 - 8 - 10 mm
Threads	GAS conical ISO 7 (BSPT) GAS cylindrical ISO 228 (BSP); M5-M6 and other metric threads available on request; NPT on request Micro models: M3 - M5 - M7 - G1/8 - G1/4
Temperature	-20°C ÷ 80°C (see the technical data of tubing used) Micro models: -10°C ÷ 80°C (see the technical data of tubing used)
Tube to connect	Polyamide (PA) 6 - 11 - 12, Polyurethane (PU), Polyethylene (PE), hytrel Polyester
Fluid	compressed air (for other types of fluid, contact our engineers)
Materials	- standard models: body and collet in nickel-plated brass, O-Ring in NBR, thread seals in PTFE - NBR - PA - models with self-retaining device: body and collet in nickel-plated brass, poppet valve in brass, spring in stainless steel, O-Ring in NBR, thread seals in PTFE
Working pressure	- standard models: min -0,9 bar - max 16 bar (see tubing) - models with self-retaining device: 0 ÷ 16 bar

Fitting with connecting tube

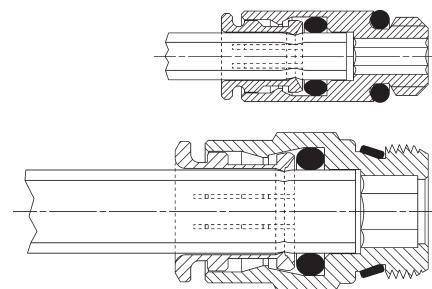

Fittings Mod. S6510

Male Connector Sprint®



DIMENSIONS										
Mod.	A	D	C	F	G	H	L	SW	SW1	Weight (g)
S6510 4-1/8	4	G1/8	3.8	8.8	13.2	5.5	18	12	2.5	9
S6510 4-1/4	4	G1/4	5.5	8.8	15.2	7	19.5	14	2.5	15
S6510 5-1/8	5	G1/8	3.8	9.8	13.2	5.5	19	12	3	8
S6510 5-1/4	5	G1/4	5.5	9.8	15.2	7	20	14	3	14
S6510 6-1/8	6	G1/8	6	11.7	13.2	5.5	22	12	4	10
S6510 6-1/4	6	G1/4	5.5	11.7	15.2	7	21	14	4	14
S6510 6-3/8	6	G3/8	6.5	11.7	20.5	8	22.5	19	4	27
S6510 8-1/8	8	G1/8	7.5	13.7	15.2	5.5	25	14	5	13
S6510 8-1/4	8	G1/4	6.5	13.7	15.2	7	24	14	6	14
S6510 8-3/8	8	G3/8	6	13.7	20.5	8	23.5	19	6	25
S6510 8-1/2	8	G1/2	7.5	13.7	24.5	9	25	22	6	43
S6510 10-1/4	10	G1/4	8.3	15.4	18.5	7	28.5	17	7	23
S6510 10-3/8	10	G3/8	5.3	15.4	20.5	8	25.5	19	8	27
S6510 10-1/2	10	G1/2	4.8	16	24.5	9	25	22	8	39
S6510 12-1/4	12	G1/4	10.3	18.3	20.5	7	29.5	19	7	26
S6510 12-3/8	12	G3/8	9.3	18.3	20.5	8	28.5	19	9	30
S6510 12-1/2	12	G1/2	5.8	18.3	24.5	9	25	22	10	36
S6510 14-3/8	14	G3/8	10.3	20.5	24.5	8	30.5	22	9	42
S6510 14-1/2	14	G1/2	6.3	20.5	24.5	9	26.5	22	12	34
S6510 16-1/2	16	G1/2	9	23.5	26.5	9	32	24	-	42
S6510 16-3/4	16	G3/4	3.5	23.5	27.3	9	26.5	24	-	46

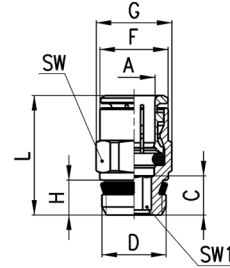

Fittings Mod. S6510...-LF

Male Connector Sprint® with self-retaining device

This version interrupts the air flow when the tube is disconnected and restores it when reconnected.

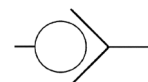
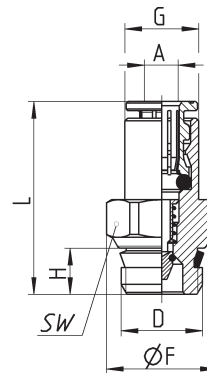

DIMENSIONS									
Mod.	A	D	F	G	H	L	SW	Weight (g)	
S6510 4-1/8-LF	4	G1/8	13.2	8.8	5.5	23	12	11	
S6510 6-1/8-LF	6	G1/8	13.2	11.7	6	30.5	12	15	

Fittings Mod. 6512 Micro

Metric-BSP Male Connector

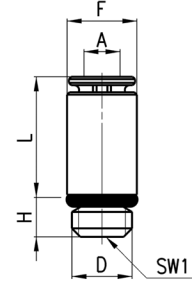

DIMENSIONS								
Mod.	A	D	F	H	L	SW1	Weight (g)	
6512 3-M3	3	M3	5.8	2.5	10.2	1.5	1	*
6512 3-M5	3	M5	5.8	3.5	10	2	1	•
6512 4-M7-M	4	M7	9.4	5	17.5	2.5	5	•
6512 4-1/8-M	4	G1/8	11.2	5	13	2.5	9	•, Y
6512 6-M7-M	6	M7	10.4	5	17	4	7	•
6512 6-1/8-M	6	G1/8	11.2	5	14	4	7	•, Y
6512 8-1/8-M	8	G1/8	12.4	5	18.5	5	10	•, Y
6512 10-1/4-M	10	G1/4	14.8	6	21	7	16	•

* = with gasket
• = with O-Ring

Fittings Mod. 6512

Metric-BSP Male Connector



New sizes

DIMENSIONS										
Mod.	A	D	C	F	G	H	L	SW	SW1	Weight (g)
6512 4-M5	4	M5	14.0	7.8	8.8	4	20	8	2	4
6512 4-M6	4	M6	14.0	8.8	9.9	4.5	20.5	9	2.5	6
6512 4-1/8	4	G1/8	14.0	8.8	13.5	6	19	12	2.5	10
6512 4-1/4	4	G1/4	14.0	8.8	16.4	7	20.5	15	2.5	14
6512 5-M5	5	M5	15.0	8.8	9.9	4	21	9	2	5
6512 6-M5	6	M5	16.0	11.7	13.2	4	22	12	2	8
6512 6-M6	6	M6	16.0	11.7	13.2	4.5	22.5	12	2.5	8
6512 6-1/8	6	G1/8	16.0	11.7	13.5	6	21	12	4	10
6512 6-1/4	6	G1/4	16.0	11.7	16.4	7	22	15	4	13
6512 8-1/8	8	G1/8	17.5	13.7	15.2	6	26	14	5	15
6512 8-1/4	8	G1/4	17.5	13.7	16.4	7	24.5	15	6	17
6512 8-3/8	8	G3/8	17.5	13.7	20.5	7	23	19	6	27
6512 10-1/4	10	G1/4	20.2	15.4	18.5	7	30	17	7	26
6512 10-3/8	10	G3/8	20.2	15.4	20.5	7	24.5	19	8	27
6512 10-1/2	10	G1/2	20.2	15.4	24.8	8	25	22	8	39
6512 12-1/4	12	G1/4	19.2	18.3	20.5	7	29.5	19	7	29
6512 12-3/8	12	G3/8	19.2	18.3	20.5	7	24	19	9	24
6512 12-1/2	12	G1/2	19.2	18.3	24.8	8	24.5	22	9	37
6512 14-3/8	14	G3/8	20.2	20.5	24.5	7	30.5	22	10	38
6512 14-1/2	14	G1/2	20.2	20.5	24.8	8	25.5	22	10	35
6512 16-1/2	16	G1/2	23.0	23.5	26.5	8	33.5	24	-	49

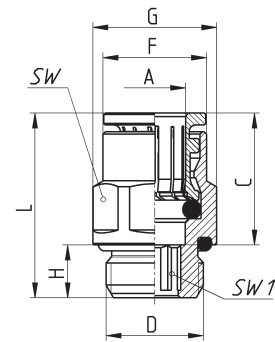

Fittings Mod. 6463

Metric-BSP Female Connector

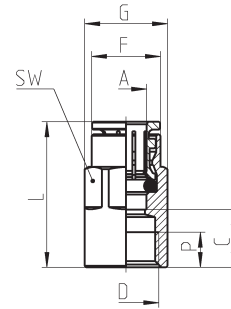

DIMENSIONS									
Mod.	A	D	C	F	G	L	P (min)	SW	Weight (g)
6463 4-M5	4	M5	6.5	7.8	8.8	20.5	4.5	9	8
6463 4-1/8	4	G1/8	10	9	13	24	6	12	14
6463 5-1/8	5	G1/8	10	9.8	13	25	6	12	14
6463 6-1/8	6	G1/8	10	11.7	13	26	6	12	14
6463 6-1/4	6	G1/4	11.5	11.9	16.5	27.5	7	15	23
6463 8-1/8	8	G1/8	9.5	13.7	15.2	27	6	14	16
6463 8-1/4	8	G1/4	11.5	13.7	16.5	29	7	15	23
6463 10-1/4	10	G1/4	11.3	15.4	18.5	31.5	7	17	29

Fittings Mod. S6520

Swivel Male Elbow Sprint®

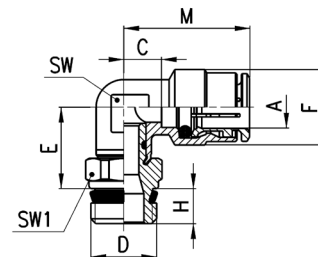

DIMENSIONS										
Mod.	A	D	C	E	F	H	M	SW	SW1	Weight (g)
S6520 4-1/8	4	G1/8	3.5	14.5	9	5.5	17.5	8	12	17
S6520 4-1/4	4	G1/4	3.5	14.5	9	7	17.5	8	14	23
S6520 5-1/8	5	G1/8	5.5	14.5	10	5.5	20.5	9	12	17
S6520 5-1/4	5	G1/4	5.5	14.5	10	7	20.5	9	14	23
S6520 6-1/8	6	G1/8	4	15	12.7	5.5	20	9	12	20
S6520 6-1/4	6	G1/4	4	15	12.7	7	20	9	14	23
S6520 6-3/8	6	G3/8	4	15.5	12.7	8	20	9	19	33
S6520 8-1/8	8	G1/8	5	16	14.2	5.5	22.5	11	12	22
S6520 8-1/4	8	G1/4	5	16	14.2	7	22.5	11	14	26
S6520 8-3/8	8	G3/8	5	16.5	14.2	8	22.5	11	19	41
S6520 8-1/2	8	G1/2	5	17	14.2	9	22.5	11	22	48
S6520 10-1/4	10	G1/4	5.8	18.5	16.5	7	26	13	14	32
S6520 10-3/8	10	G3/8	5.8	19	16.5	8	26	13	19	43
S6520 10-1/2	10	G1/2	5.8	19.5	16.5	9	26	13	22	62
S6520 12-1/4	12	G1/4	7.3	20	19.5	7	26.5	15	17	49
S6520 12-3/8	12	G3/8	7.3	20	19.5	8	26.5	15	19	48
S6520 12-1/2	12	G1/2	7.3	20.5	19.5	9	26.5	15	22	70
S6520 14-3/8	14	G3/8	8.3	21	21.5	8	28.5	17	19	74
S6520 14-1/2	14	G1/2	8.3	21.5	21.5	9	28.5	17	22	78

Fittings Mod. 6522 Micro

Metric Swivel Male Elbow

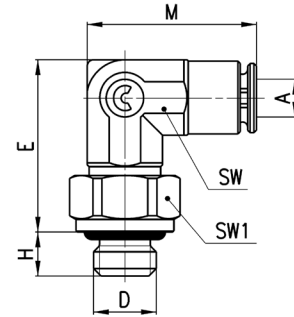

DIMENSIONS									
Mod.	A	D	E	H	M	SW	SW1	Weight (g)	
6522 3-M3	3	M3	13.7	2.5	13.7	6	6	4	*
6522 3-M5	3	M5	13.7	3.5	13.7	6	8	5	•

* = with gasket
• = with O-Ring

Fittings Mod. 6522

New sizes

Metric-BSP Swivel Male Elbow

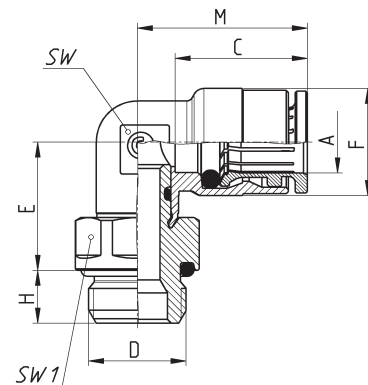

DIMENSIONS										
Mod.	A	D	C	E	F	H	M	SW	SW1	Weight (g)
6522 4-M5	4	M5	14.0	12.5	9	4	17.5	8	8	12
6522 4-1/8	4	G1/8	14.0	14.5	9	6	17.5	8	12	15
6522 4-1/4	4	G1/4	14.0	15.5	9	7	17.5	8	15	25
6522 5-M5	5	M5	15.0	12.5	10	4	20.5	9	8	13
6522 6-M5	6	M5	16.0	13	12.7	4	20	9	10	14
6522 6-1/8	6	G1/8	16.0	15	12.7	6	20	9	12	19
6522 6-1/4	6	G1/4	16.0	16	12.7	7	20	9	15	27
6522 8-1/8	8	G1/8	17.5	16	14.2	6	22.5	11	12	22
6522 8-1/4	8	G1/4	17.5	17	14.2	7	22.5	11	15	28
6522 8-3/8	8	G3/8	17.5	17	14.2	7	22.5	11	19	45
6522 10-1/4	10	G1/4	20.2	19.5	16.5	7	26	13	15	41
6522 10-3/8	10	G3/8	20.2	19.5	16.5	7	26	13	19	45
6522 10-1/2	10	G1/2	20.2	20.5	16.5	8	26	13	22	53
6522 12-1/4	12	G1/4	19.2	20	19.5	7	26.5	15	17	51
6522 12-3/8	12	G3/8	19.2	20.5	19.5	7	26.5	15	19	56
6522 12-1/2	12	G1/2	19.2	21.5	19.5	8	26.5	15	22	58
6522 14-3/8	14	G3/8	20.2	21.5	21.5	7	28.5	17	19	53
6522 14-1/2	14	G1/2	20.2	22.5	21.5	8	28.5	17	22	61

Fittings Mod. S6500

Metric Fix Male Elbow

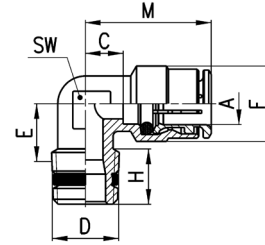

DIMENSIONS									
Mod.	A	D	C	E	F	H	M	SW	Weight (g)
S6500 4-1/8	4	R1/8	3.5	8.5	9	7.5	17.5	8	9
S6500 4-1/4	4	R1/4	5	11.5	9	12	19	9	13
S6500 5-1/8	5	R1/8	5.5	8.5	10	7.5	20.5	9	13
S6500 5-1/4	5	R1/4	5.5	11.5	10	12	20.5	9	17
S6500 6-1/8	6	R1/8	4	9	12.7	7.5	20	9	15
S6500 6-1/4	6	R1/4	4	11.5	12.7	12	20	9	16
S6500 8-1/8	8	R1/8	5	10.5	14.2	6.5	22.5	11	18
S6500 8-1/4	8	R1/4	5	11.5	14.2	12.5	22.5	11	21
S6500 8-3/8	8	R3/8	7	13	14.2	11.5	24.5	12	25
S6500 10-1/4	10	R1/4	5.8	13	16.5	11.5	26	13	33
S6500 10-3/8	10	R3/8	5.8	13	16.5	12	26	13	33
S6500 12-1/4	12	R1/4	7.3	14.5	19.5	11	26.5	15	46
S6500 12-3/8	12	R3/8	7.3	13.5	19.5	11.5	26.5	15	39

Fittings Mod. 6525

Long Swivel Male Elbow Sprint®

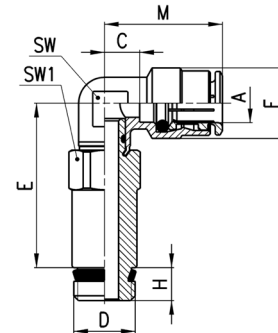

DIMENSIONS										
Mod.	A	D	C	E	F	H	M	SW	SW1	Weight (g)
6525 6-1/8	6	G1/8	4	33.8	12.7	5.5	20	9	12	34
6525 6-1/4	6	G1/4	4	34	12.7	7	20	9	14	47
6525 8-1/8	8	G1/8	5	34.8	14.2	5.5	22.5	11	12	35
6525 8-1/4	8	G1/4	5	35	14.2	7	22.5	11	14	50

Fittings Mod. 6621 Micro



Complete Metric Adjustable
Single Banjo

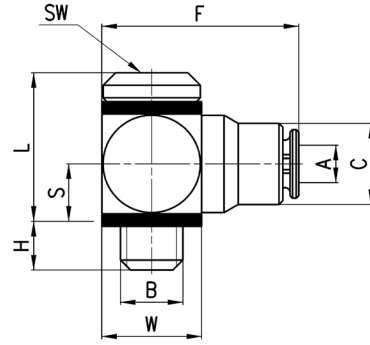

DIMENSIONS										
Mod.	A	B	C	F	H	L	S	W	SW	Weight (g)
6621 3-M3	3	M3	5.8	14.2	2.5	9.3	3.5	6	1.5	5
6621 3-M5	3	M5	6.5	16	3.2	11.9	4.8	8	2	6

Fitting Mod. 6501 4-M5



Metric Fix Male Elbow

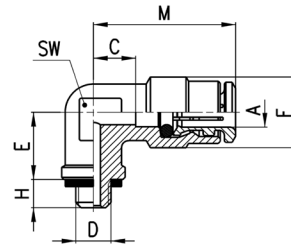

DIMENSIONS									
Mod.	A	D	C	E	F	H	M	SW	Weight (g)
6501 4-M5	4	M5	3.5	6	9	4	17.5	8	11

Fittings Mod. S6430

Swivel Male Tee Sprint®

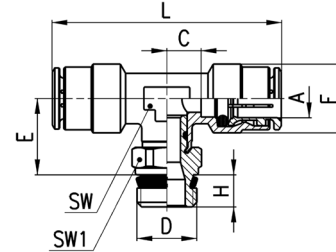

DIMENSIONS										
Mod.	A	D	C	E	F	H	L	SW	SW1	Weight (g)
S6430 4-1/8	4	G1/8	3.5	14.5	9	5.5	35	8	12	18
S6430 5-1/8	5	G1/8	5.5	14.5	10	5.5	41	9	12	24
S6430 5-1/4	5	G1/4	5.5	14.5	10	7	41	9	14	30
S6430 6-1/8	6	G1/8	4	15	12.7	5.5	40	9	12	28
S6430 6-1/4	6	G1/4	4	15	12.7	7	40	9	14	33
S6430 8-1/8	8	G1/8	5	16	14.2	5.5	45	11	12	37
S6430 8-1/4	8	G1/4	5	16	14.2	7	45	11	14	42
S6430 8-3/8	8	G3/8	5	16.5	14.2	8	45	11	19	51
S6430 10-1/4	10	G1/4	5.8	18.5	16.5	7	52	13	14	56
S6430 10-3/8	10	G3/8	5.8	19	16.5	8	52	13	19	67
S6430 10-1/2	10	G1/2	5.8	19.5	16.5	9	52	13	22	85
S6430 12-1/4	12	G1/4	7.3	20	19.5	7	53	15	17	60
S6430 12-3/8	12	G3/8	7.3	20	19.5	8	53	15	19	65
S6430 12-1/2	12	G1/2	7.3	20.5	19.5	9	53	15	22	89
S6430 14-1/2	14	G1/2	8.3	21.5	21.5	9	57	17	22	88

Fittings Mod. 6432 Micro

Metric Swivel Male Tee

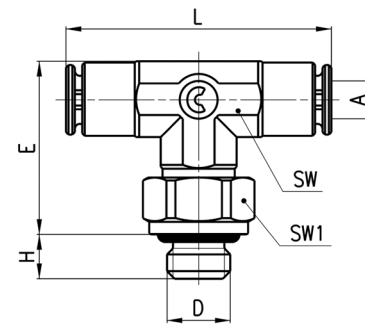

DIMENSIONS									
Mod.	A	D	E	H	L	SW	SW1	Weight (g)	
6432 3-M3	3	M3	13.7	2.5	21.4	6	6	5	*
6432 3-M5	3	M5	13.7	3.5	21.4	6	8	6	•

* = with gasket
• = with O-Ring

Fittings Mod. 6432

Metric-BSP Swivel Male Tee

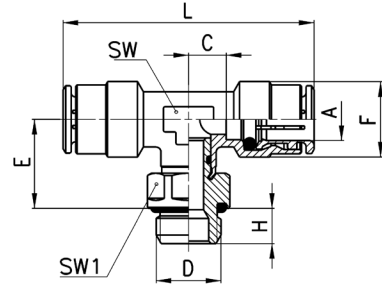

DIMENSIONS										
Mod.	A	D	C	E	F	H	L	SW	SW1	Weight (g)
6432 4-M5	4	M5	3.5	12.5	9	4	35	8	8	14
6432 4-1/8	4	G1/8	3.5	14.5	9	6	35	8	12	19
6432 5-M5	5	M5	5.5	12.5	10	4	41	9	8	19
6432 6-1/8	6	G1/8	4	15	12.7	6	40	9	12	29
6432 6-1/4	6	G1/4	4	16	12.7	7	40	9	15	30
6432 8-1/8	8	G1/8	5	16	14.2	6	45	11	12	37
6432 8-1/4	8	G1/4	5	17	14.2	7	45	11	15	39
6432 8-3/8	8	G3/8	5	17	14.2	7	45	11	19	55
6432 10-1/4	10	G1/4	5.8	19.5	16.5	7	52	13	15	59
6432 10-3/8	10	G3/8	5.8	19.5	16.5	7	52	13	19	56
6432 12-1/4	12	G1/4	7.3	20	19.5	7	53	15	17	60
6432 12-3/8	12	G3/8	7.3	20.5	19.5	7	53	15	19	80

Fittings Mod. S6440

Lateral Swivel Male Tee Sprint®

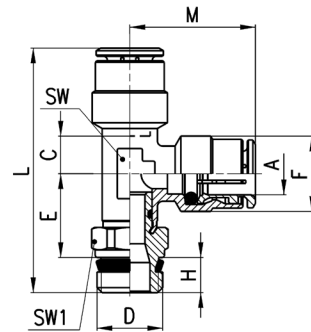

DIMENSIONS											
Mod.	A	D	C	E	F	H	L	M	SW	SW1	Weight (g)
S6440 4-1/8	4	G1/8	3.5	14.5	9	5.5	37.5	17.5	8	12	23
S6440 5-1/8	5	G1/8	5.5	14.5	10	5.5	40.5	20.5	9	12	24
S6440 6-1/8	6	G1/8	4	15	12.7	5.5	40.5	20	9	12	26
S6440 6-1/4	6	G1/4	4	15	12.7	7	42	20	9	14	31
S6440 8-1/8	8	G1/8	5	16	14.2	5.5	44	22.5	11	12	37
S6440 8-1/4	8	G1/4	5	16	14.2	7	45.5	22.5	11	14	35
S6440 8-3/8	8	G3/8	5	16.5	14.2	8	47	22.5	11	19	52
S6440 10-1/4	10	G1/4	5.8	18.5	16.5	7	51.5	26	13	14	43
S6440 10-3/8	10	G3/8	5.8	18.5	16.5	8	53	26	13	19	66
S6440 12-3/8	12	G3/8	7.3	19.5	19.5	8	54.5	26.5	15	19	65
S6440 14-1/2	14	G1/2	8.3	21.5	21.5	9	59	28.5	17	22	88

Fittings Mod. 6442 Micro



Lateral Metric Swivel Male Tee

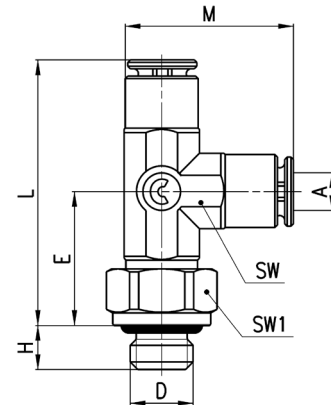

DIMENSIONS										
Mod.	A	D	E	H	L	M	SW	SW1	Weight (g)	
6442 3-M3	3	M3	10.7	2.5	21.4	13.7	6	6	5	*
6442 3-M5	3	M5	12.2	3.5	21.4	13.7	6	8	6	•

* = with gasket
• = with O-Ring

Fittings Mod. 6442



Lateral Metric-BSP Swivel Male Tee

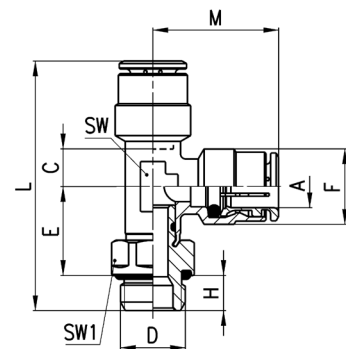

DIMENSIONS											
Mod.	A	D	C	E	F	H	L	M	SW	SW1	Weight (g)
6442 4-M5	4	M5	3.5	12.5	9	4	34	17.5	8	8	18
6442 4-1/8	4	G1/8	3.5	14.5	9	6	38	17.5	8	12	19
6442 5-M5	5	M5	5.5	12.5	10	4	36.5	20.5	9	8	19
6442 6-1/8	6	G1/8	4	15	12.7	6	41	20	9	12	26
6442 6-1/4	6	G1/4	4	16	12.7	7	43	20	9	15	36
6442 8-1/8	8	G1/8	5	16	14.2	6	44.5	22.5	11	12	31
6442 8-1/4	8	G1/4	5	17	14.2	7	46.5	22.5	11	15	42
6442 8-3/8	8	G3/8	5	17	14.2	7	46.5	22.5	11	19	50
6442 10-1/4	10	G1/4	5.8	19.5	16.5	7	52.5	26	13	15	46
6442 10-3/8	10	G3/8	5.8	19.5	16.5	7	52.5	26	13	19	66
6442 12-1/4	12	G1/4	7.3	20	16.5	7	53.5	26.5	15	17	73
6442 12-3/8	12	G3/8	7.3	20.5	19.5	7	54	26.5	15	19	64

Fittings Mod. 6452 Micro



Metric Swivel Male Y

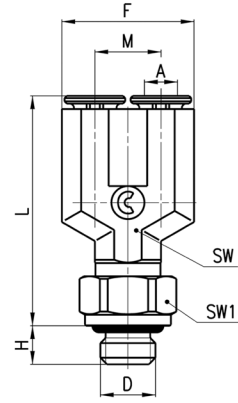

DIMENSIONS										
Mod.	A	D	F	H	L	M	SW	SW1	Weight (g)	
6452 3-M3	3	M3	12	2.5	20.9	6	6	6	6	*
6452 3-M5	3	M5	12	3.5	20.9	6	6	8	7	•

* = with gasket
• = with O-Ring

Fittings Mod. 6451 - S6450



Mod. 6451: Metric Adjustable Male Y

Mod. S6450: Swivel Male Y Sprint®

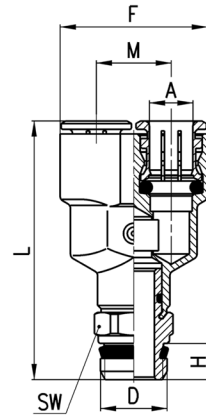

DIMENSIONS									
Mod.	A	D	F	H	L	M	SW	Weight (g)	
6451 4-M5	4	M5	18	4	26.5	9	-	17	*
6451 6-M5	6	M5	24.5	4	29.5	12.5	-	27	*
S6450 4-1/8	4	G1/8	18	5.5	38	9	12	23	
S6450 6-1/8	6	G1/8	24.5	5.5	41.5	12.5	12	33	
S6450 8-1/8	8	G1/8	28.5	5.5	48.5	14.5	14	48	
S6450 8-1/4	8	G1/4	28.5	7	50	14.5	14	50	

* = not swivel Model with gasket

Fittings Mod. 6622

Complete BSP Swivel Single Banjo

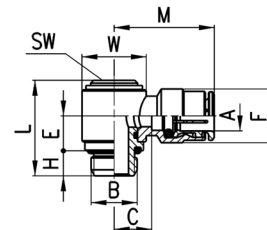

DIMENSIONS											
Mod.	A	B	C	E	F	H	L	M	SW	W	Weight (g)
6622 4-M5	4	M5	4	5.7	8.8	4	15.8	18	2.5	Ø 8	10
6622 4-1/8	4	G1/8	7.5	10.2	9	5	25	21.5	4	Ø 14	22
6622 6-1/8	6	G1/8	8	10.2	12.7	5	25	24	4	Ø 14	24
6622 6-1/4	6	G1/4	10	9.1	12.7	6	25.3	26	5	Ø 18	35
6622 8-1/8	8	G1/8	8	10.2	14.2	5	25	25.5	4	Ø 14	28
6622 8-1/4	8	G1/4	10	9.1	14.2	6	25.3	27.5	5	Ø 18	39
6622 10-1/4	10	G1/4	8.8	9.1	16.5	6	25.3	29	5	Ø 18	42

* = Complete Metric Swivel Single Banjo

Fittings Mod. 6632

Complete BSP Swivel
Double Banjo

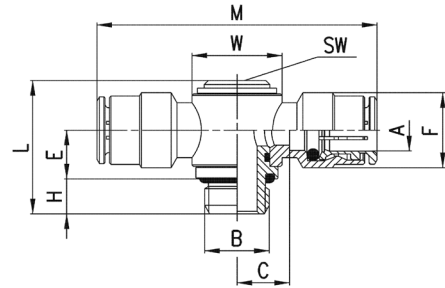

DIMENSIONS											
Mod.	A	B	C	E	F	H	L	M	W	SW	Weight (g)
6632 4-1/8	4	G1/8	7.5	10.2	9	5	25	43	∅ 14	4	24
6632 6-1/8	6	G1/8	8	10.2	12.7	5	25	48	∅ 14	4	33
6632 6-1/4	6	G1/4	10	9.1	12.7	6	25.3	52	∅ 18	5	35
6632 8-1/8	8	G1/8	8	10.2	14.2	5	25	51	∅ 14	4	39
6632 8-1/4	8	G1/4	10	9.1	14.2	6	25.3	55	∅ 18	5	40
6632 10-1/4	10	G1/4	8.8	9.1	16.5	6	25.3	58	∅ 18	5	50

Fittings Mod. 6620

Double Banjo

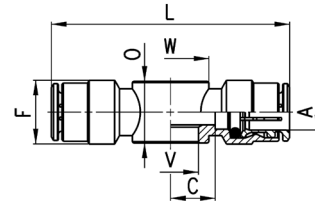

DIMENSIONS										
Mod.	A	C	F	L	O	V	W	Weight (g)	assembled with Mod.	
6620 4-M5	4	5	9	38	9	5.1	∅ 9	13	SCU, SVU, SCO...	
6620 4-1/8	4	7.5	9	43	14.5	9.8	∅ 14	19	1631, 1635, SCU, SVU, SCO...	
6620 6-1/8	6	8	12.7	48	14.5	9.8	∅ 14	24	1631, 1635, SCU, SVU, SCO...	
6620 6-1/4	6	10	12.7	52	14.5	13.2	∅ 18	26	1631, 1635, SCU, SVU, SCO...	
6620 8-1/8	8	8	14.2	51	14.5	9.8	∅ 14	32	1631, 1635, SCU, SVU, SCO...	
6620 8-1/4	8	10	14.2	55	14.5	13.2	∅ 18	34	1631, 1635, SCU, SVU, SCO...	

Fittings Mod. 1631 with gaskets

01... = Single Banjo Stem
02... = Double Banjo Stem
03... = Triple Banjo Stem



Mod.
1631 01-
1631 02-
1631 03-

Drawings and dimensions on page
2.05.09

Fittings Mod. 6610

Single Banjo

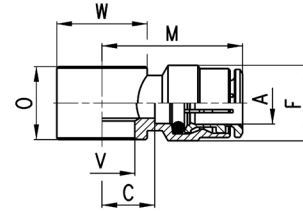

DIMENSIONS									
Mod.	A	C	F	M	O	V	W	Weight (g)	assembled with Mod.
6610 4-M5	4	5	9	19	9	5.1	9	9	1631
6610 4-M6	4	5	9	19	9	5.1	9	8	SCU, SVU, SCO...
6610 4-1/8	4	7.5	9	21.5	14.5	9.8	∅ 14	14	1631, 1635, SCU, SVU, SCO...
6610 5-M5	5	5	10	20	9	5.1	9	9	1631
6610 5-M6	5	5	10	20	9	5.1	9	8	SCU, SVU, SCO...
6610 5-1/8	5	8	10	23	14.5	9.8	∅ 14	16	1631, 1635, SCU, SVU, SCO...
6610 6-M5	6	6.5	12.7	22.5	9	5.1	∅ 10	12	1631
6610 6-M6	6	6.5	12.7	22.5	9	5.1	∅ 10	12	SCU, SVU, SCO...
6610 6-1/8	6	8	12.7	24	14.5	9.8	∅ 14	16	1631, 1635, SCU, SVU, SCO...
6610 6-1/4	6	10	12.7	26	14.5	13.2	∅ 18	19	1631, 1635, SCU, SVU, SCO...
6610 8-1/8	8	8	14.2	25.5	14.5	9.8	∅ 14	19	1631, 1635, SCU, SVU, SCO...
6610 8-1/4	8	10	14.2	27.5	14.5	13.2	∅ 18	22	1631, 1635, SCU, SVU, SCO...
6610 8-3/8	8	11	14.2	28.5	14.5	16.7	∅ 21	23	1631, 1635, SCU, SVU, SCO...
6610 10-1/4	10	8.8	16.5	29	14.5	13.2	∅ 18	22	1635, SCU, SVU, SCO...
6610 10-3/8	10	10.3	16.5	30.5	14.5	16.7	∅ 21	23	1635, SCU, SVU, SCO...
6610 12-1/2	12	12,8	16,5	32	14,5	21	∅ 26	37	1635

Fittings Mod. 6811

Metric Male Adaptor Sprint®

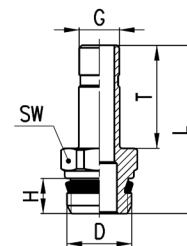

DIMENSIONS							
Mod.	G	D	H	T	L	SW	Weight (g)
6811 4-M5	4	M5	4	16.5	24.5	8	3 *
6811 4-1/8	4	G1/8	5.5	16.5	27.8	12	10
6811 5-1/8	5	G1/8	5.5	18	29.3	12	9
6811 5-1/4	5	G1/4	7	18	31	14	11
6811 6-1/8	6	G1/8	5.5	18	29.3	12	10
6811 6-1/4	6	G1/4	7	18	31	14	12
6811 8-1/8	8	G1/8	5.5	20.5	31.8	12	12
6811 8-1/4	8	G1/4	7	20.5	33.5	14	13
6811 10-1/4	10	G1/4	7	23	36	14	16
6811 10-3/8	10	G3/8	8	23	37.3	19	25
6811 12-3/8	12	G3/8	8	24	38.3	19	25
6811 14-1/2	14	G1/2	9	28	44	22	39

* = with O-Ring

Fittings Mod. S6110



45° Male Elbow Sprint®

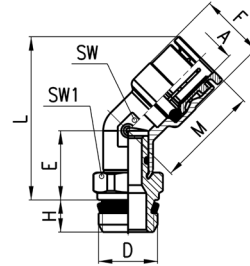

DIMENSIONS										
Mod.	A	D	E	F	H	L	M	SW	SW1	Weight (g)
S6110 6-1/8	6	G1/8	14	12.7	5.5	32.5	20.5	11	12	21
S6110 6-1/4	6	G1/4	14	12.7	7	34.5	20.5	11	14	25
S6110 8-1/8	8	G1/8	14	14.2	5.5	32.5	22.5	11	12	21
S6110 8-1/4	8	G1/4	14	14.2	7	34.5	22.5	11	14	26
S6110 8-3/8	8	G3/8	14.5	14.2	8	35	22.5	11	19	38
S6110 10-1/4	10	G1/4	15.5	16.5	7	39.5	26.5	15	17	39
S6110 10-3/8	10	G3/8	15.5	16.5	8	39.5	26.5	15	19	44
S6110 10-1/2	10	G1/2	16	16.5	9	40	26.5	15	22	57
S6110 12-1/4	12	G1/4	15.5	19.5	7	40.5	26.5	15	17	41
S6110 12-3/8	12	G3/8	15.5	19.5	8	40.5	26.5	15	19	46
S6110 12-1/2	12	G1/2	16	19.5	9	41	26.5	15	22	59

Fittings Mod. 6590 Micro

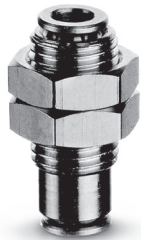

Bulkhead Connector

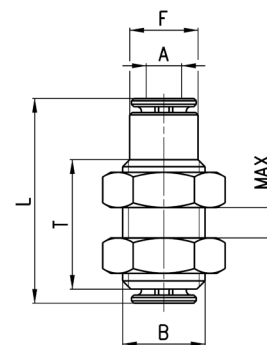

DIMENSIONS							
Mod.	A	B	F	L	MAX	T	Weight (g)
6590 3	3	M7x0.75	5.8	18.4	5	11.4	4

Fittings Mod. 6590

Bulkhead Connector

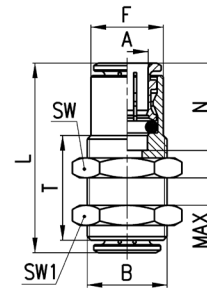

DIMENSIONS										
Mod.	A	B	F	L	N	MAX	SW	SW1	T	Weight (g)
6590 4	4	M10x1	8.8	29	14	10.5	14	14	20	16
6590 5	5	M12x1	9.8	31	15	10.5	17	17	20	25
6590 6	6	M14x1	12.5	33	16	10.5	17	17	20	28
6590 8	8	M16x1	14.5	36	17.5	11.5	19	19	21	35
6590 10	10	M18x1	16.3	41.5	20.2	13	22	22	23.5	51
6590 12	12	M20x1	18.8	39.5	19.2	14.5	24	24	25	56
6590 14	14	M22x1	20.5	41.5	20.2	17.5	27	27	30	82

Fittings Mod. 6580 Micro

Union Connector

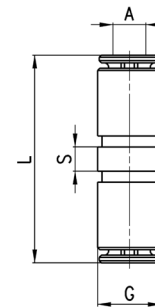

DIMENSIONS					
Mod.	A	G	L	S	Weight (g)
6580 3	3	5.8	19.9	2.2	2

Fittings Mod. 6580

Union Connector

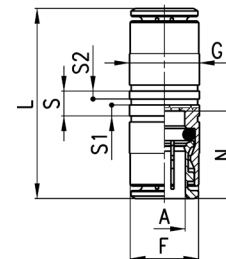

DIMENSIONS									
Mod.	A	F	G	L	N	S	S1	S2	Weight (g)
6580 4	4	8.4	9	29	14	5	2.2	1.6	11
6580 5	5	9.4	10	31	15	5	2.2	1.6	15
6580 6	6	11.7	12	34	16	5	2.2	1.6	16
6580 8	8	13.7	14	37	17.5	5	2.2	1.6	23
6580 10	10	15.4	17	41.5	20.2	5	2.2	1.6	33
6580 12	12	18.3	19	39.5	19.2	5.2	2.2	1.6	40
6580 14	14	20.5	21	41.5	20.2	5.2	2.2	1.6	47
6580 16	16	-	47	47	23	-	-	-	60

Fittings Mod. 6580 - Reducer

Reducer Union Connector

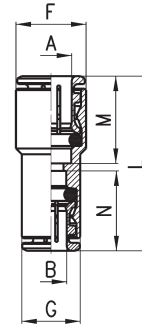

DIMENSIONS									
Mod.	A	B	F	G	L	M	N	Weight (g)	
6580 6-4	6	4	12	9	31.5	16	14	12	
6580 8-6	8	6	14	12.2	35	17.5	16	19	
6580 10-8	10	8	16	14	39	20	17.5	25	
6580 12-10	12	10	19	16	40.5	19	20	35	

Fittings Mod. 6593

BSP Female Bulkhead

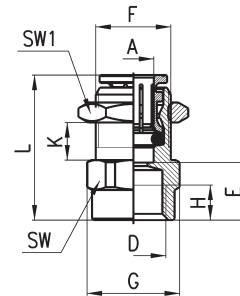

DIMENSIONS												
Mod.	A	D	E	F	G	H	L	K (max)	K (min)	SW	SW1	Weight (g)
6593 6-1/8	6	G1/8	10	M12x1	16.4	6	24.5	8.5	2	15	17	19
6593 6-1/4	6	G1/4	11.5	M12x1	18.5	7	26	6.5	2	17	17	22
6593 8-1/8	8	G1/8	10	M15x1	18.5	6	27	9.5	2	17	19	26
6593 8-1/4	8	G1/4	11.5	M15x1	18.5	7	28.5	9.5	2	17	19	26
6593 10-3/8	10	G3/8	12.8	M18x1	24.5	8	32.5	12	2	22	22	43

Fittings Mod. 6550 Micro

Elbow connector

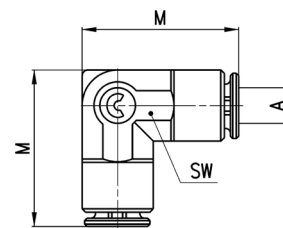

DIMENSIONS				
Mod.	A	M	SW	Weight (g)
6550 3	3	13.7	6	3

Fittings Mod. 6550

Elbow connector

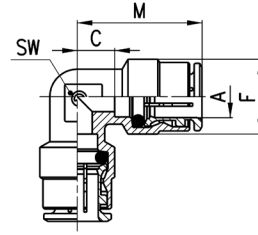

DIMENSIONS						
Mod.	A	C	F	M	SW	Weight (g)
6550 4	4	3.5	9	17.5	8	8
6550 5	5	5.5	10	20.5	9	15
6550 6	6	4	12.7	20	9	17
6550 8	8	5	14.2	22.5	11	22
6550 10	10	5.8	16.5	26	13	30
6550 12	12	7.3	19.5	26.5	15	44
6550 14	14	8.3	21.5	28.5	17	71

Fittings Mod. 6540 Micro

Tee Connector

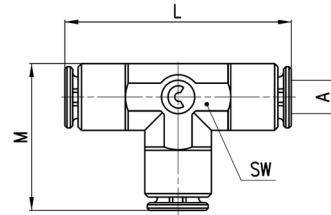

DIMENSIONS					
Mod.	A	L	M	SW	Weight (g)
6540 3	3	21.4	13.7	6	4

Fittings Mod. 6540

Tee Connector

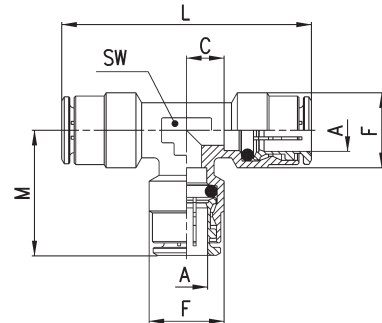

DIMENSIONS							
Mod.	A	C	F	L	M	SW	Weight (g)
6540 4	4	3.5	9	35	17.5	8	14
6540 5	5	5.5	10	41	20.5	9	21
6540 6	6	4	12.7	40	20	9	24
6540 8	8	5	14.2	45	22.5	11	32
6540 10	10	5.8	16.5	52	26	13	43
6540 12	12	7.3	19.5	53	26.5	15	60
6540 14	14	8.3	21.5	57	28.5	17	75

Fittings Mod. 6600



Cross Junction

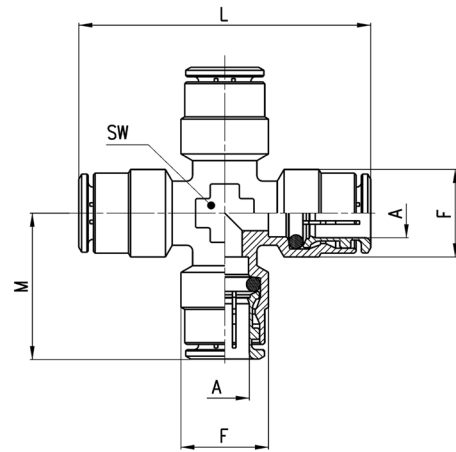

DIMENSIONS						
Mod.	A	F	L	M	SW	Weight (g)
6600 4	4	9	38	19	9	26
6600 5	5	10	41	20.5	9	29
6600 6	6	12.7	44	22	10	35
6600 8	8	14.2	49	24.5	12	50
6600 10	10	16.5	55	27.5	14	63
6600 12	12	19.5	56	28	16	84

Fittings Mod. 6560 Micro

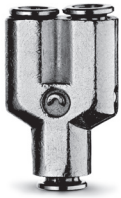

Y Union

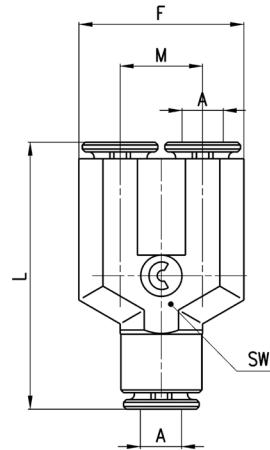

DIMENSIONS						
Mod.	A	F	L	M	SW	Weight (g)
6560 3	3	12	20.4	6	6	5

Fittings Mod. 6560



Y Union

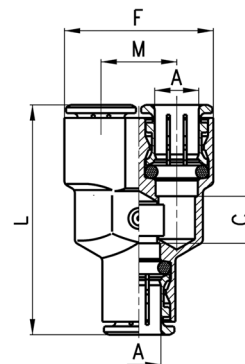

DIMENSIONS						
Mod.	A	C	F	L	M	Weight (g)
6560 4	4	5	18	33	9	19
6560 6	6	7	24.5	39	12.5	30
6560 8	8	9	28.5	44	14.5	42
6560 10	10	15.5	32	53.5	16	63

Fittings Mod. 6700

Cartridge



S* = for both metallic and synthetic seat

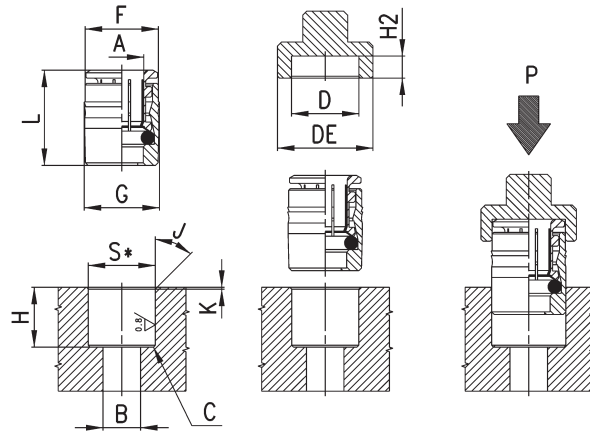

Mod.	A	B	C	D	DE	F	G	H	H2 (+0,1/0)	J	K	L	P min (Kg)	P max (Kg)	S (+0,01/-0,04)	Weight (g)
6700 3	3	2	0.5x45°	6.1	11	5.9	6.2	6.3	2.6	30°	0.3	9.2	80	350	6	1
6700 4	4	3.5	0.5x45°	8.8	14	8.6	9	11	3.3	15°	0.5	14.5	200	360	8.75	4
6700 5	5	3.5	0.5x45°	9.8	15	9.6	10	11.5	3.3	15°	0.5	15.5	230	450	9.75	5
6700 6	6	4	0.5x45°	12	17	11.8	12.2	12	3.8	15°	0.5	16.5	160	570	11.95	8
6700 8	8	6	0.5x45°	14	19	13.8	14.2	14	3.3	15°	0.5	18	140	400	13.95	11
6700 10	10	8	0.5x45°	16	21	15.8	16.2	16.5	3.5	15°	0.5	20.5	150	650	15.95	15

Fittings Mod. 3053

News

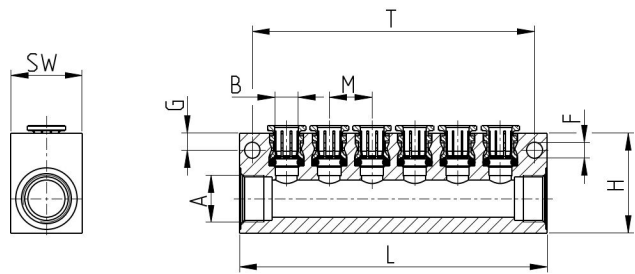

Mod.	A	SINGLE LATERAL OUTLETS	B	L	G	M	T	H	F	SW	Weight (g)
3053 1/4-8L-4	G1/4	8	4	97	4,5	10	88	30	4,5	20	140
3053 1/4-8L-6	G1/4	8	6	120	4,5	13	111	30	4,5	20	172
3053 3/8-6L-8	G3/8	6	8	108	6	15	99	35	5,5	25	210
3053 1/2-6L-10	G1/2	6	10	127	6,5	17	118	45	5,5	30	365

Fittings Mod. 6750

Female Plug

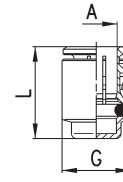

DIMENSIONS				
Mod.	A	G	L	Weight (g)
6750 4	4	8.8	15	4
6750 6	6	11.8	17	7
6750 8	8	13.8	18.5	9
6750 10	10	15.8	21	12
6750 12	12	17.8	20	15

Fittings Mod. 6850

Enlarger Junction

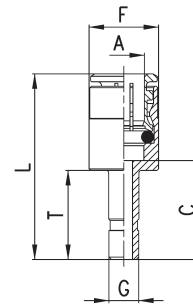

DIMENSIONS							
Mod.	A	G	C	F	L	T	Weight (g)
6850 6-4	6	4	17.5	12.7	33.5	16.5	11
6850 8-6	8	6	19	14	36.5	18	15

Fitting Mod. 6800 Micro

Reducer Junction

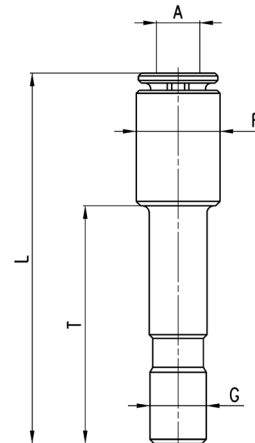

DIMENSIONS						
Mod.	A	F	G	L	T	Weight (g)
6800 3-4	3	5.8	4	26	16.5	2

Fittings Mod. 6800



Reducer Junction

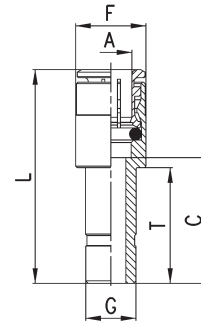

DIMENSIONS							
Mod.	A	G	C	F	L	T	Weight (g)
6800 4-5	4	5	19	9	33	18	8
6800 4-6	4	6	15.5	9	29.5	18	9
6800 4-8	4	8	18	9	32	20.5	10
6800 5-6	5	6	19	10	34	18	11
6800 5-8	5	8	18	10	33	20.5	12
6800 6-8	6	8	18	12.7	34	20.5	12
6800 6-10	6	10	20.5	12.7	36.5	23	17
6800 6-12	6	12	17.5	12.7	33.5	24	21
6800 8-10	8	10	20.5	14	38	23	15
6800 8-12	8	12	21.5	14	39	24	22
6800 10-12	10	12	20.3	16.5	40.5	24	27
6800 10-14	10	14	24.3	16.5	44.5	28	33
6800 12-14	12	14	24.3	18.8	45.5	28	27

Fittings Mod. 6950



Junction

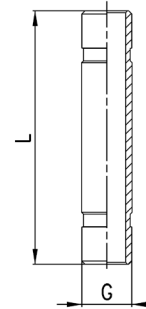

DIMENSIONS			
Mod.	G	L	Weight (g)
6950 4	4	32.5	3
6950 6	6	35.5	4
6950 8	8	40.5	7
6950 10	10	46	10
6950 12	12	48	13
6950 14	14	52	17

Fittings Mod. 6555

Junction Elbow

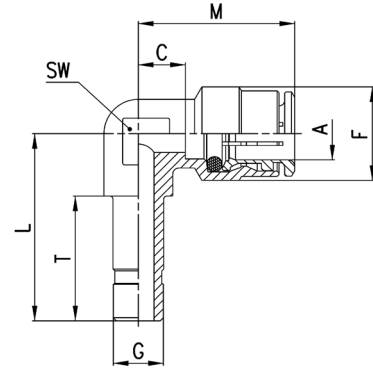

DIMENSIONS									
Mod.	A	G	C	L	F	T	M	SW	Weight (g)
6555 4-4	4	4	3.5	22	9	16.5	17.5	9	8
6555 6-6	6	6	4	24.5	12.7	18	20	9	14
6555 8-8	8	8	5	27.5	14.2	20	22.5	11	21
6555 10-10	10	10	5.8	32	16.5	23	26	13	26

Fittings Mod. 6708

Protection caps
Colour: Black
Self-extinguishing material, class V0

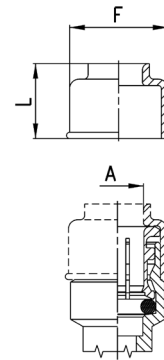

DIMENSIONS				
Mod.	A	F	L	Weight (g)
6708 4	4	10.7	10.7	1
6708 5	5	11.7	11	1
6708 6	6	13.7	11.5	1
6708 8	8	15.7	12.5	1
6708 10	10	18.5	13	1
6708 12	12	20.7	15	2
6708 14	14	23.7	15	2

Accessory Mod. 6900 Micro

Plastic Male Plug

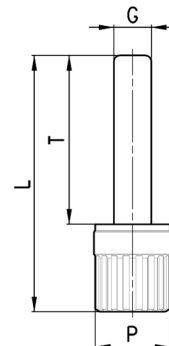

DIMENSIONS					
Mod.	G	L	P	T	Weight (g)
6900 3	3	20.5	6	13.5	1

Accessory Mod. 6900



Plastic Male Plug

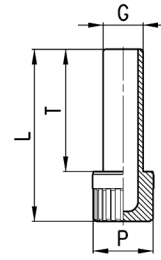

DIMENSIONS					
Mod.	G	L	P	T	Weight (g)
6900 4	4	29	8	20	1
6900 5	5	29.5	8	20.5	1
6900 6	6	31.5	8	22.5	1
6900 8	8	34.5	12	24.5	2
6900 10	10	37	12	27	2
6900 12	12	40.5	16	28.5	3
6900 14	14	42.5	16	30.5	3

Accessory Mod. SP



Disconnecting tube set

The set includes keys to disconnect tubes with diameters between 4 and 12 mm.

Mod.
SP